



## CR24-.. Single room controllers

### Table of contents

<b>Overview of the system</b>	2
<b>Overview of functions</b>	3
<b>Technical data sheets</b>	
CR24-B1 / CR24-A1 Single room controllers	5
CR24-B2 / CR24-A2 Single room controllers	7
CR24-B2E / CR24-A2E Single room controllers	9
CR24-B3 / CR24-A3 Single room controllers	13
<b>Operation</b>	15
<b>Functions</b>	
Setpoint calculation	17
Energy hold off / Stand-by / VAV-Function	18
Electric air heater / External temperature sensor / Supply air temperature limitation	19
External setpoint shift / Air flush	20
Change-over	21
Boost	22
Chilled ceiling	23
Rolling start / Excess temperature protection / Step control	24
<b>Dimensions, Installation, Commissioning, Service</b>	25

Single room controllers



CR24-B1



CR24-B2



CR24-B2E



CR24-B3

VAV applications

Compact



Universal

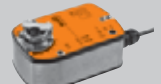

Water applications



Rotary actuators and control ball valves

Air applications



Damper actuators



**Brief description**

The new developed CR24-.. controller generation provides the foundation for modern single room concepts. The technology, functionality and handling of the new microprocessor-controlled room temperature controllers are perfectly adapted to the BELIMO actuators for motorized air and water final controlling elements. The functional classification into three basic types with up to three output sequences and the large number of specific applications facilitate cost-effective system solutions for individually controlling the room climate and reducing energy consumption. The controllers can be used in both pure VAV and combined systems with 2 and 4-pipe water applications (radiators, air heaters/coolers, heated/chilled ceilings).

**Device variants**



**Notes**

Unless otherwise expressly mentioned, all references contained in this document to the CR24-B.. also apply to the CR24-A...

Standard CR24-B.. type with operator panel (setpoint adjustment, mode switch and status indication). For operation, refer to page 15.

Type CR24-A..: same functionality as the CR24-B.. but without an operator panel.

**Accessories**

	Type	Description
<b>Mechanical accessories</b>	CRZA-A	Spare cover for A-types
	CRZA-B	Spare cover for B-types (with operation panel)
	CRZW	Spare baseplate, fitting to all types

**Overview of CR24-B.. functions**

	CR24-B1	CR24-B2	CR24-B2E	CR24-B3
<b>Power supply</b> AC 24 V / 50/60Hz	•	•	•	•
<b>Application / Temperature range</b>				
– Room temperature control in comfort zone	•	•	•	•
– Internal temperature sensor (Type NTC, sensing range 10...45°C)	•	•	•	•
– Setpoint (adjustment range 15...36°C)	•	•	•	•
<b>Operation</b> (CR24-B.. only)	•	•	•	•
– Mode selection Switch: AUTO – ECO – MAX	•	•	•	•
– Mode indication LEDs: AUTO – ECO – MAX	•	•	•	•
– Setpoint adjustm. Rotary knob: ±3 K	•	•	•	•
<b>Inputs</b> Number	4	5	5	5
– Energy hold off	•	•	•	•
– Stand-by	• 1)	•	•	•
– Change-over	• 1)			• 2)
– Chilled ceiling with dew point limiting and change-over				• 2)
– Air flush		•	•	
– Boost			•	• 2)
– External temperature sensor (Type NTC, sensing range 10...45°C)	•	•	•	•
– External setpoint shift 0...10 V	•	•	•	•
<b>Outputs</b> Number	1	2	3	3
– (0)2...10 V system output for Belimo VAV controller or change-over	• 3)			
– (0)2...10 V system output for Belimo VAV controller		•	•	•
– Heating output 3-point		•	•	•
– Electrical reheater 1 ... 3 stages or on/off radiator valve			•	
– Heating or cooling output, change-over 0...10 V				• 4)
<b>Functions</b>				
– Control characteristics	P	P	P	P / PI
– P-band switchable	•	•	•	•
– Boost function $\dot{V}_{max}$ or temperature-controlled, selectable				•
– Boost function temperature-controlled			•	
– Volume increase in heating mode, selectable		•	•	•
– Internal function test, including nominal voltage test	•	•	•	•
– Commissioning mode with output and sequence simulation	•	•	•	•
– VAV controller diagnosis via integrated PC-Tool connection	•	•	•	•
<b>Mounting</b>				
Surface mounting with flush-mounted or surface-mounted connection	•	•	•	•
<b>Housing colors</b>				
Baseplate NCS2005-R80B light gray (corresponds approx. to RAL 7035)	•	•	•	•
Cover RAL 9003 signal white				

- 1) The stand-by input is not available in change-over (C/O) mode or in heating controller applications, as it is assigned to the change-over input function. CR24-B3 should be used if the stand-by function is needed in a change-over application.
- 2) The boost function is not available in change-over mode or in chilled ceiling applications with dew point limiting. A combination of change-over and dew point limiting is possible.
- 3) The output can either be used as a common cooling and heating output in change-over mode or exclusively as a cooling or heating output. The stand-by function is not available in change-over mode or in heating controller applications.
- 4) The output can either be used as a common cooling and heating output in change-over mode or exclusively as a cooling or heating output.

**Additional documentation**

Comprehensive and regularly updated documentation with descriptions of specific applications is available for all controllers.

Temperature controllers for single room applications with one analog output:

- The analog output ao1 can be used in VAV applications to control one or more VAV controllers.
- In change-over applications, the analog output ao1 can be changed over from cooling to heating mode via an input.



### Device variants

Type CR24-A1, same functionality as the CR24-B1 but without an operator panel.

### Technical data

<b>Electrical data</b>	Nominal voltage	AC 24 V 50/60 Hz
	For wire sizing	3 VA, without actuators
	Power supply range	AC 19.2...28.8 V
	Connections	Terminal block 1...3: 2.5 mm <sup>2</sup> Terminal block 4...8: 1.5 mm <sup>2</sup>
<b>Functional data</b>	Control characteristics	P
	– P-band heating / cooling	Selectable: 1.5 / 1.0 K or 3.0 / 2.0 K
	External temperature sensor (ai1)	Type NTC, 5 kΩ, sensing range 10...45°C for example Belimo type TFK
	Heating setpoint	Range 15...36°C (default 21°C)
	– Energy hold off	Heating 15°C / cooling 40°C
	– Stand-by	Heating –2 K / cooling +3 K
	Dead band	1 K
	Frost limit temperature	10°C
	Operation (CR24-B.. only)	
	– Mode switch and status indication (LEDs)	AUTO (green) – ECO (orange) – MAX (red)
– Rotary knob for setpoint adjustment	±3 K	
Communication port for field devices	2 x PP (for PC-Tool, MFT remote control etc.)	
<b>Inputs</b>	2 x analog, 2 x digital	
	– External temperature sensor (ai1)	Type NTC, 5 kΩ, sensing range 10...45°C
	– External setpoint shift (ai2)	0...10 V corresponds to 0...10 K
	– Digital inputs (di1, di2)	Contact rating 10 mA
<b>Outputs</b>	1 x analog	
	– VAV system output (ao1)	(0)2 ... 10 V, max. 5 mA
<b>Norms und standards</b>	Protection class	III Safety extra-low voltage
	Degree of protection	IP 30 to EN 60529
	Mode of operation	Type 1 to EN 60730-1
	Software class	A to EN 60730-1
	EMC	<b>CE</b> conformity to 89/336/EEC
	Ambient conditions	
	– Operation	0...+50°C / 20...90% rH (without condensation)
– Transport and storage	–25...+70°C / 20...90% rH (without condensation)	
<b>Dimensions / Weight</b>	Dimensions (H x W x D)	99 x 84 x 32 mm
	Weight	105 g
<b>Housing colors</b>	Baseplate	NCS2005-R80B light gray (corresponds approx. to RAL 7035)
	Cover	RAL 9003-Signalweiss

### Safety notes



- The controller is not allowed to be used outside the specified field of application, especially in aircraft or in any other airborne means of transport.
- It may only be installed by suitably trained personnel.  
All applicable legal or institutional installation regulations must be complied with.
- The device may only be opened at the manufacturer's site. It does not contain any parts that can be replaced or repaired by the user.
- The device contains electrical and electronic components and is not allowed to be disposed of as household refuse. All locally valid regulations and requirements must be observed.

**Product features**

- Energy hold off** In energy saving mode, the room temperature is reduced to building protection level, i.e. either the heating setpoint is significantly reduced or the cooling setpoint is significantly increased, for instance in a room with an open window.
- Stand-by** The room temperature is reduced to stand-by level, i.e. either the heating setpoint is slightly reduced or the cooling setpoint is slightly increased, for instance in a room that is temporarily unoccupied.
- Frost** The frost protection function is activated if the actual room temperature falls below 10 °C.
- Change-over** Change-over heating or heating/cooling.
- External temperature sensor** An external temperature sensor can be connected to the analog input ai1, for instance in order to measure the average room temperature in the exhaust air duct.
- External setpoint shift** An external DC 0...10 V signal at the analog input ai2 can be used to shift the basic setpoint 0...10 K, for instance for the summer/winter compensation.  
*These functions are described in detail on pages 17 to 24.*

**Configuration / Principal diagramm**

**Configuration**



DIP	Default settings	
1	P-band <b>normal</b>	P-band <b>wide</b>
2	Input di2 <b>Stand-by</b>	Input di2 <b>Change-over</b>

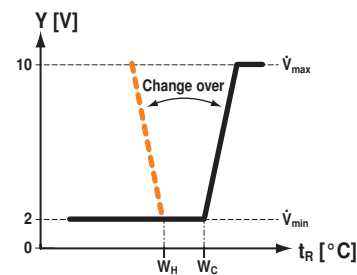
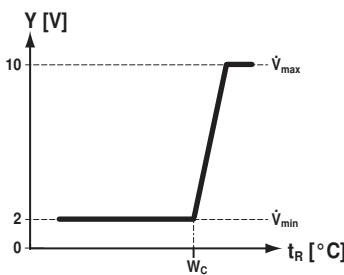

Key			
Y [V]	Output voltage in volt	$\dot{V}_{max}$	Maximum volume flow
$t_R$ [°C]	Room temperature in degrees centigrade	$\dot{V}_{min}$	Minimum volume flow
$W_H$	Heating setpoint		
$W_C$	Cooling setpoint		

**Electrical installation**

**Wiring diagram**

**Notes**

- Connect via safety isolation transformer.
- Parallel connection of other actuators possible. Note the performance data.

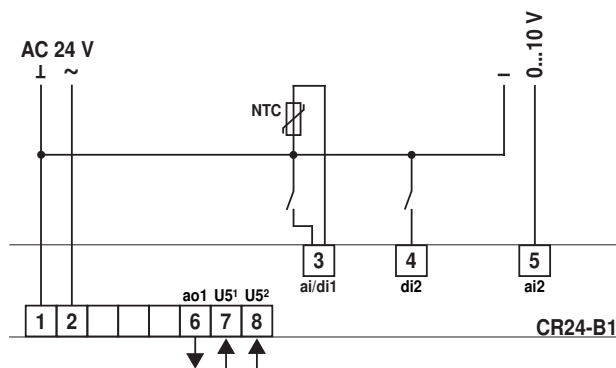

Inputs			Outputs	
3	ai1	External temperature sensor	6	ao1 System output for Belimo VAV controller
	di1	Energy hold off	<b>Other connections</b>	
4	di2	Stand-by / Change-over	7	PP1 Diagnostics socket 1
5	ai2	External setpoint shift	8	PP2 Diagnostics socket 2

Temperature controllers for single room applications with two analog outputs:

- The analog output ao1 can be used in VAV applications to control one or more VAV controllers.
- The analog heating output ao3 supplies a 3-point signal.



### Device variants

Type CR24-A2, same functionality as the CR24-B2 but without an operator panel.

### Technical data

<b>Electrical data</b>	Nominal voltage	AC 24 V 50/60 Hz
	For wire sizing	3 VA, without actuators
	Power supply range	AC 19.2...28.8 V
	Connections	Terminal block 1...3: 2.5 mm <sup>2</sup> Terminal block 4...8: 1.5 mm <sup>2</sup>
<b>Functional data</b>	Control characteristics	P
	– P-band heating / cooling	Selectable: 1.5 / 1.0 K or 3.0 / 2.0 K
	External temperature sensor (ai1)	Type NTC, 5 kΩ, sensing range 10...45°C for example Belimo type TFK
	Heating setpoint	Range 15...36°C (default 21°C)
	– Energy hold off	Heating 15°C / cooling 40°C
	– Stand-by	Heating –2 K / cooling +3 K
	Dead band	1 K
	Frost limit temperature	10°C
	Operation (CR24-B.. only)	
	– Mode switch and status indication (LEDs)	AUTO (green) – ECO (orange) – MAX (red)
– Rotary knob for setpoint adjustment	±3 K	
Communication port for field devices	2 x PP (for PC-Tool, MFT remote control etc.)	
<b>Inputs</b>	2 x analog, 3 x digital	
	– External temperature sensor (ai1)	Type NTC, 5 kΩ, sensing range 10...45°C
	– External setpoint shift (ai2)	0...10 V corresponds to 0...10 K
	– Digital inputs (di1, di2, di3)	Contact rating 10 mA
<b>Outputs</b>	2 x analog	
	– VAV system output (ao1)	(0)2 ... 10 V, max. 5 mA
	– Heating output (ao3)	3-point, AC 24 V, max. source current 0.5 A / 10 VA (optimized for actuators with a running time of approx. 150 s)
<b>Norms und standards</b>	Protection class	III Safety extra-low voltage
	Degree of protection	IP 30 to EN 60529
	Mode of operation	Type 1 to EN 60730-1
	Software class	A to EN 60730-1
	EMC	<b>CE</b> conformity to 89/336/EEC
	Ambient conditions	
	– Operation	0...+50°C / 20...90% rH (without condensation)
– Transport and storage	–25...+70°C / 20...90% rH (without condensation)	
<b>Dimensions / Weight</b>	Dimensions (H x W x D)	99 x 84 x 32 mm
	Weight	105 g
<b>Housing colors</b>	Baseplate	NCS2005-R80B light gray (corresponds approx. to RAL 7035)
	Cover	RAL 9003-Signalweiss

### Safety notes



- The controller is not allowed to be used outside the specified field of application, especially in aircraft or in any other airborne means of transport.
- It may only be installed by suitably trained personnel.  
All applicable legal or institutional installation regulations must be complied with.
- The device may only be opened at the manufacturer's site. It does not contain any parts that can be replaced or repaired by the user.
- The device contains electrical and electronic components and is not allowed to be disposed of as household refuse. All locally valid regulations and requirements must be observed.

**Product features**

- Energy hold off** In energy saving mode, the room temperature is reduced to building protection level, i.e. either the heating setpoint is significantly reduced or the cooling setpoint is significantly increased, for instance in a room with an open window.
- Stand-by** The room temperature is reduced to stand-by level, i.e. either the heating setpoint is slightly reduced or the cooling setpoint is slightly increased, for instance in a room that is temporarily unoccupied.
- Frost** The frost protection function is activated if the actual room temperature falls below 10 °C.
- Air flush** The room can be ventilated with the maximum volume flow ( $\dot{V}_{max}$ ), for instance in order to purge conference rooms, hotel rooms etc.
- External temperature sensor** An external temperature sensor can be connected to the analog input ai1, for instance in order to measure the average room temperature in the exhaust air duct.
- External setpoint shift** An external DC 0...10 V signal at the analog input ai2 can be used to shift the basic setpoint 0...10 K, for instance for the summer/winter compensation.  
*These functions are described in detail on pages 17 to 24.*

**Configuration / Principal diagramm**

**Configuration**



DIP	Default-settings	
1	P-band <b>normal</b>	P-band <b>wide</b>
2	$\dot{V}_{max}$ heating <b>off</b>	$\dot{V}_{max}$ heating <b>80%</b>

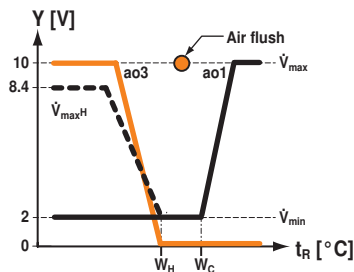

Legende			
Y [V]	Output voltage in volt	ao..	Analog outputs
tR [°C]	Room temperature in degrees centigrade	$\dot{V}_{max}$	Maximum volume flow
WH	Heating setpoint	$\dot{V}_{maxH}$	Maximum volume flow heating
WC	Cooling setpoint	$\dot{V}_{min}$	Minimum volume flow

**Electrical installation**

**Wiring diagram**

**Notes**

- Connect via safety isolation transformer.
- Parallel connection of other actuators possible. Note the performance data.

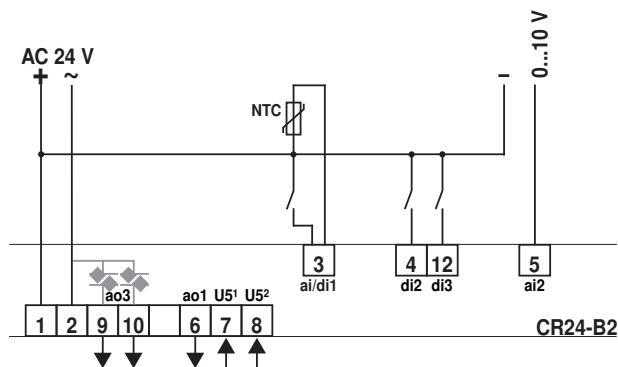

Inputs			Outputs		
3	ai1	External temperature sensor	6	ao1	System output for Belimo VAV controller
	di1	Energy hold off	9/10	ao3	Heating (3-point)
4	di2	Stand-by	<b>Other connections</b>		
5	ai2	External setpoint shift	7	PP1	Diagnostics socket 1
12	di3	Air flush	8	PP2	Diagnostics socket 2



Temperature controllers for single room applications with one analog output and two digital outputs:

- The analog output ao1 for cooling, e.g. in VAV applications to control one or more VAV controllers.
- The digital heating output do3 for
  - electrical reheater with one or two stages, in binary mode with three stages
  - on/off radiator valve



### Device variants

Type CR24-A2E, same functionality as the CR24-B2E but without an operator panel.

### Technical data

<b>Electrical data</b>	Nominal voltage	AC 24 V 50/60 Hz
	For wire sizing	3 VA, without actuators
	Power supply range	AC 19.2...28.8 V
	Connections	Terminal block 1...3: 2.5 mm <sup>2</sup> Terminal block 4...8: 1.5 mm <sup>2</sup>
<b>Functional data</b>	Control characteristics	P
	– P-band heating / cooling	2 K with 2 resp. 3 stages / 2.0 K
	External temperature sensor (ai1)	Type NTC, 5 kΩ, sensing range 10...45 °C for example Belimo type TFK
	Heating setpoint	Range 15...36 °C (default 21 °C)
	– Energy hold off	Heating 15 °C / cooling 40 °C
	– Stand-by	Heating –2 K / cooling +3 K
	Dead band	1 K
	Frost limit temperature	10 °C
	Operation (CR24-B.. only)	
	– Mode switch and status indication (LEDs)	AUTO (green) – ECO (orange) – MAX (red)
– Rotary knob for setpoint adjustment	±3 K	
Communication port for field devices	2 x PP (for PC-Tool, MFT remote control etc.)	
<b>Inputs</b>	2 x analog, 3 x digital	
	– External temperature sensor (ai1)	Type NTC, 5 kΩ, sensing range 30...50 °C
	– External setpoint shift (ai2)	0...10 V corresponds to 0...10 K
	– Digital inputs (di1, di2, di3)	Contact rating 10 mA
<b>Outputs</b>	1 x analog, 2 x digital	
	– VAV system output (ao1)	(0)2 ... 10 V, max. 5 mA
	– Heating output (do3), 2 stages	Triac, AC 24 V, max. source current 0.5 A / 10 VA
<b>Norms und standards</b>	Protection class	III Safety extra-low voltage
	Degree of protection	IP 30 to EN 60529
	Mode of operation	Type 1 to EN 60730-1
	Software class	A to EN 60730-1
	EMC	<b>CE</b> conformity to 89/336/EEC
	Ambient conditions	
	– Operation	0...+50 °C / 20...90% rH (without condensation)
– Transport and storage	–25...+70 °C / 20...90% rH (without condensation)	
<b>Dimensions / Weight</b>	Dimensions (H x W x D)	99 x 84 x 32 mm
	Weight	105 g
<b>Housing colors</b>	Baseplate	NCS2005-R80B light gray (corresponds approx. to RAL 7035)
	Cover	RAL 9003-Signalweiss

### Safety notes



- The controller is not allowed to be used outside the specified field of application, especially in aircraft or in any other airborne means of transport.
- It may only be installed by suitably trained personnel.  
All applicable legal or institutional installation regulations must be complied with.
- The device may only be opened at the manufacturer's site. It does not contain any parts that can be replaced or repaired by the user.
- The device contains electrical and electronic components and is not allowed to be disposed of as household refuse. All locally valid regulations and requirements must be observed.

Product features

- Energy hold off** In energy saving mode, the room temperature is reduced to building protection level, i.e. either the heating setpoint is significantly reduced or the cooling setpoint is significantly increased, for instance in a room with an open window.
- Stand-by** The room temperature is reduced to stand-by level, i.e. either the heating setpoint is slightly reduced or the cooling setpoint is slightly increased, for instance in a room that is temporarily unoccupied.
- Frost** The frost protection function is activated if the actual room temperature falls below 10 °C.
- Boost** The room can be ventilated with the maximum volume flow ( $\dot{V}_{max}$ ) or heated up with the maximum capacity.
- Supply air temperature limiter** An optional mounted sensor allows to control the supply air temperature to a maximum of 50 °C.
- $\dot{V}_{max}$  at heating** For electrical reheaters the air volume at the heating condition can optionally be increased.
- Output mode** The do3 output mode can be set accordingly to the application to
  - **stage** for one-stage electrical reheater or on/off radiator valve
  - **binary** for two-stage electrical reheaters (stage I:  $1/3$ , stage II:  $2/3$ ) which will be  $1/3$ ,  $2/3$ ,  $3/3$
- Soft start (Roll-out feature)** The build-in start-up and roll-out of the stage control provides temperature excess protection. This helps to avoid service calls due to switched-off safety chains and reduces the electrical load after a power-fail.
- External setpoint shift** An external DC 0...10 V signal at the analog input ai2 can be used to shift the basic setpoint 0...10 K, for instance for the summer/winter compensation.  
*These functions are described in detail on pages 17 to 24.*

Configuration / Prinzipial diagram

Configuration



DIP	Default-settings	
1	1 or 2 stage	Binary mode
2	$\dot{V}_{max}$ heating off	$\dot{V}_{max}$ heating on

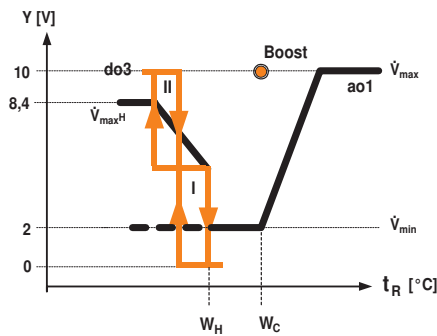

Key			
Y [V]	Output voltage in volt	ao1	Cooling output
t <sub>R</sub> [°C]	Room temperature in degrees centigrade	ao1	System output for Belimo VAV controller
W <sub>H</sub>	Heating setpoint	do3	Heating stage I
W <sub>C</sub>	Cooling setpoint	do3	Heating stage II
▼ ▲	Output on/off	$\dot{V}_{max}$	Maximum volume flow
		$\dot{V}_{maxH}$	Maximum volume flow heating
		$\dot{V}_{min}$	Minimum volume flow

**Electrical installation**

**Wiring diagram**

**Note**

- Connect via safety isolation transformer.
- Parallel connection of other actuators possible. Note the performance data.

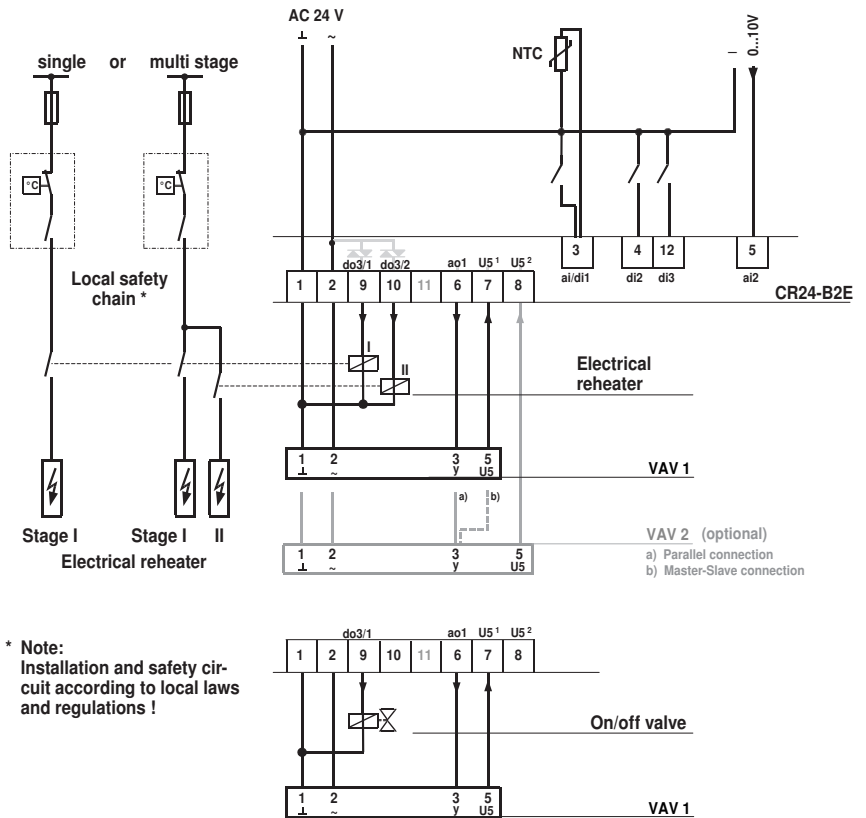

\* Note:  
Installation and safety circuit according to local laws and regulations !

Inputs			Outputs		
3	ai1	Supply air temperature limiter	6	ao1	System output for Belimo VAV controller
	di1	Energy hold off	9	do3/1	Heating stage I   On/off radiator valve
4	di2	Stand-by	10	do3/2	Heating stage II
5	ai2	External setpoint shift	<b>Other connections</b>		
12	di3	Boost	7	PP1	Diagnostics socket 1
			8	PP2	Diagnostics socket 2

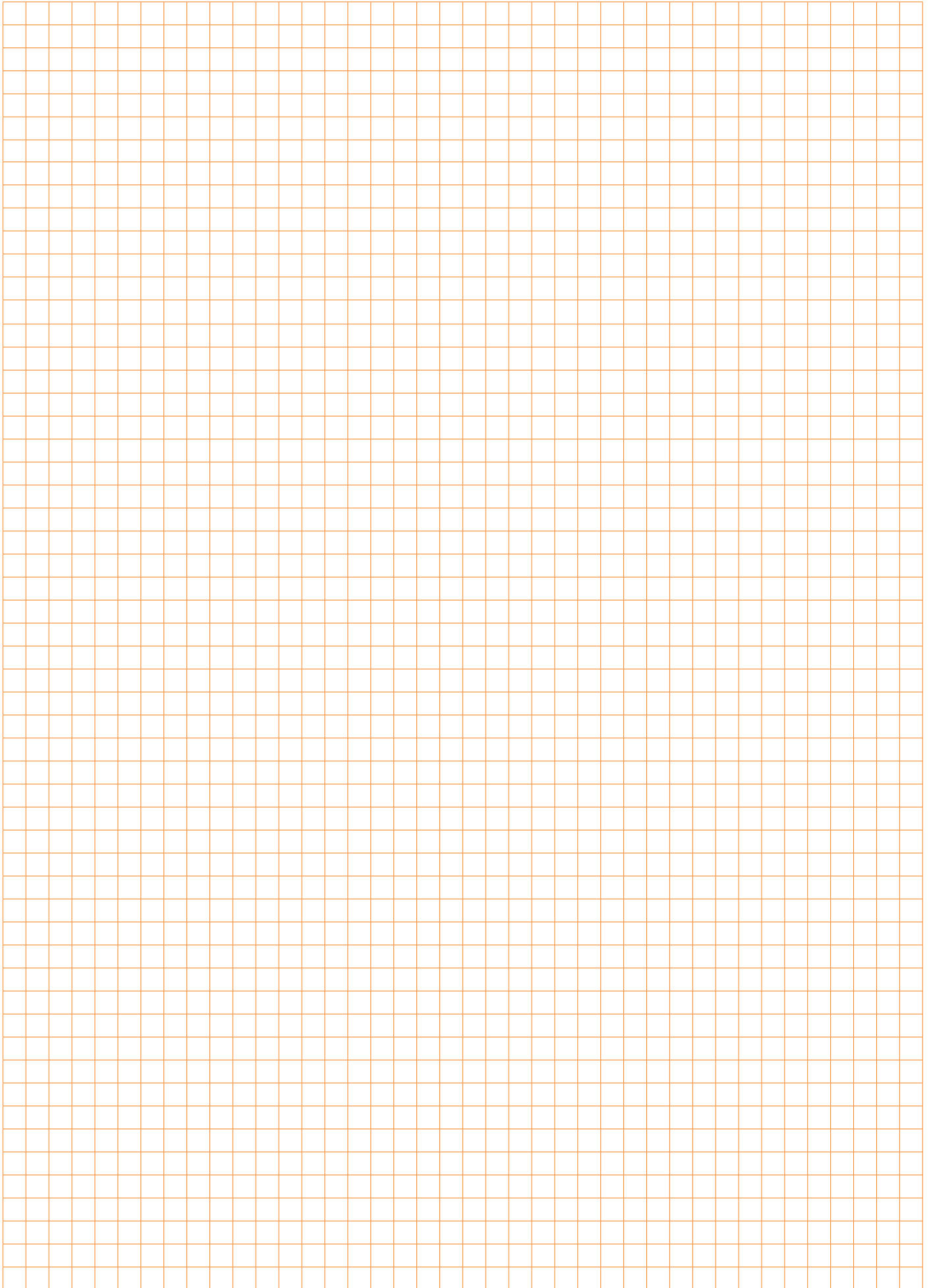

Temperature controllers for single room applications with three analog outputs:

- The analog output ao1 can be used in VAV applications to control one or more VAV controllers.
- The analog output ao2 can be used to control a heating or cooling sequence (change-over).
- The analog heating output ao3 supplies a 3-point signal.



### Device variants

Type CR24-A3, same functionality as the CR24-B3 but without an operator panel.

### Technical data

<b>Electrical data</b>	Nominal voltage	AC 24 V 50/60 Hz
	For wire sizing	3 VA, without actuators
	Power supply range	AC 19.2...28.8 V
	Connections	Terminal block 1...3: 2.5 mm <sup>2</sup> Terminal block 4...8: 1.5 mm <sup>2</sup>
<b>Functional data</b>	Control characteristics	P / PI
	– P-band heating / cooling	Selectable: 1.5 / 1.0 K or 3.0 / 2.0 K
	External temperature sensor (ai1)	Type NTC, 5 kΩ, sensing range 10...45°C for example Belimo type TFK
	Heating setpoint	Range 15...36°C (default 21°C)
	– Energy hold off	Heating 15°C / cooling 40°C
	– Stand-by	Heating –2 K / cooling +3 K
	Dead band	1 K
	Frost limit temperature	10°C
	Operation (CR24-B.. only)	
	– Mode switch and status indication (LEDs)	AUTO (green) – ECO (orange) – MAX (red)
– Rotary knob for setpoint adjustment	±3 K	
Communication port for field devices	2 x PP (for PC-Tool, MFT remote control etc.)	
<b>Inputs</b>	2 x analog, 3 x digital	
	– External temperature sensor (ai1)	Type NTC, 5 kΩ, sensing range 10...45°C
	– External setpoint shift (ai2)	0...10 V corresponds to 0...10 K
	– Digital inputs (di1, di2, di3)	Contact rating 10 mA
<b>Outputs</b>	3 x analog	
	– VAV system output (ao1)	(0)2 ... 10 V, max. 5 mA
	– Heating / cooling output (ao2)	0...10 V, max. 5 mA
	– Heating output (ao3)	3-point, AC 24 V, max. source current 0.5 A / 10 VA (optimized for actuators with a running time of approx. 150 s)
<b>Norms und standards</b>	Protection class	III Safety extra-low voltage
	Degree of protection	IP 30 to EN 60529
	Mode of operation	Type 1 to EN 60730-1
	Software class	A to EN 60730-1
	EMC	<b>CE</b> conformity to 89/336/EEC
	Ambient conditions	
	– Operation	0...+50°C / 20...90% rH (without condensation)
– Transport and storage	–25...+70°C / 20...90% rH (without condensation)	
<b>Dimensions / Weight</b>	Dimensions (H x W x D)	99 x 84 x 32 mm
	Weight	105 g
<b>Housing colors</b>	Baseplate	NCS2005-R80B light gray (corresponds approx. to RAL 7035)
	Cover	RAL 9003-Signalweiss

### Safety notes



- The controller is not allowed to be used outside the specified field of application, especially in aircraft or in any other airborne means of transport.
- It may only be installed by suitably trained personnel.  
All applicable legal or institutional installation regulations must be complied with.
- The device may only be opened at the manufacturer's site. It does not contain any parts that can be replaced or repaired by the user.
- The device contains electrical and electronic components and is not allowed to be disposed of as household refuse. All locally valid regulations and requirements must be observed.

**Product features**

- Energy hold off** In energy saving mode, the room temperature is reduced to building protection level, i.e. either the heating setpoint is significantly reduced or the cooling setpoint is significantly increased, for instance in a room with an open window.
- Stand-by** The room temperature is reduced to stand-by level, i.e. either the heating setpoint is slightly reduced or the cooling setpoint is slightly increased, for instance in a room that is temporarily unoccupied.
- Frost** The frost protection function is activated if the actual room temperature falls below 10 °C.
- Change-over** Change-over heating or heating/cooling.
- Chilled ceiling with dew point limiting** If the temperature falls below the dew point, the corresponding output is set to 0.
- Boost** The room can be ventilated with the maximum volume flow ( $\dot{V}_{max}$ ) or heated or cooled with the maximum capacity.
- External temperature sensor** An external temperature sensor can be connected to the analog input ai1, for instance in order to measure the average room temperature in the exhaust air duct.
- External setpoint shift** An external DC 0...10 V signal at the analog input ai2 can be used to shift the basic setpoint 0...10 K, for instance for the summer/winter compensation.  
*These functions are described in detail on pages 17 to 24.*

**Configuration / Prinzipal diagram**

**Configuration**



DIP	Default-settings	
1	P-band normal	P-band wide
2	$\dot{V}_{max}$ heating off	$\dot{V}_{max}$ heating 80%
3	Output ao2 Heating	Output ao2 Change-over Cooling
4	Input di3 Boost	Input di3 Change-over Dew point
5	Boost Temperature controlled	Boost $\dot{V}_{max}$
6	Control characteristic PI	Control characteristic P

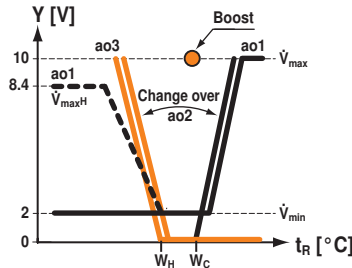

Key			
Y [V]	Output voltage in volt	ao..	Analog outputs
tR [°C]	Room temperature in degrees centigrade	$\dot{V}_{max}$	Maximum volume flow
WH	Heating setpoint	$\dot{V}_{maxH}$	Maximum volume flow heating
WC	Cooling setpoint	$\dot{V}_{min}$	Minimum volume flow

**Electrical installation**

**Wiring diagram**

**Note**

- Connect via safety isolation transformer.
- Parallel connection of other actuators possible. Note the performance data.

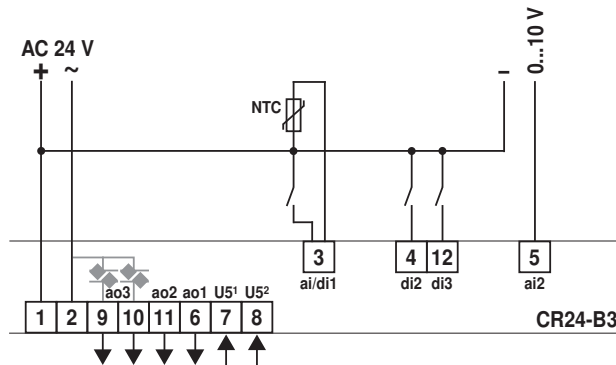

Inputs			Outputs		
3	ai1	External temperature sensor	6	ao1	System output for Belimo VAV controller
	di1	Energy hold off	9/10	ao3	Heating (3-point)
4	di2	Stand-by	11	ao2	Heating / Cooling
5	ai2	External setpoint shift	<b>Other connections</b>		
12	di3	Boost / Change-over / Dew point	7	PP1	Diagnostics socket 1
			8	PP2	Diagnostics socket 2

### Operator level 1 – Operation

### Operating mode / Setpoint

CR24-B.. only

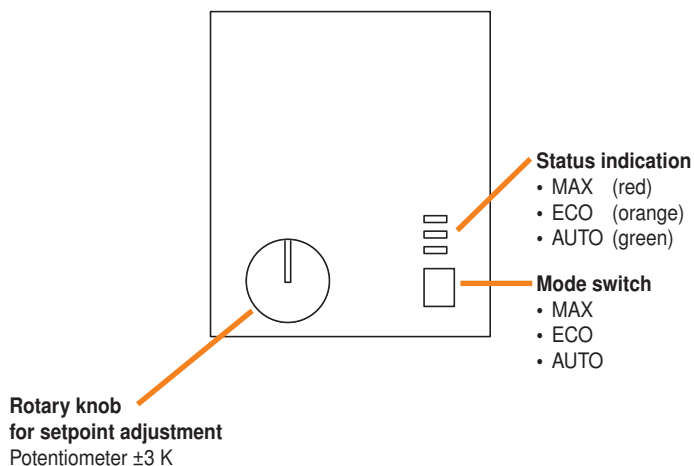

#### Mode switch and status indication

There are three possible operating modes:

- **AUTO – optimum comfort mode**

The room is heated, cooled or ventilated with the highest level of comfort, providing this is permitted by the external control signals. All the control functions (sequence control, boost function) are enabled.

- **ECO – optimum energy mode**

The room is heated, cooled or ventilated with the stand-by settings, providing this is permitted by the external control signals. The heating setpoint is reduced in this mode ( $-2$  K) and the cooling setpoint is increased ( $+3$  K). The room can be changed from "optimum energy" to "optimum comfort" in a very short time. Sequence control and the boost function are enabled. ECO mode is intended for rooms that are only irregularly occupied resp. at reduced demand.

- **MAX – boost function**

The room is ventilated with the maximum air volume or heated or cooled with the maximum capacity, providing this is permitted by the external control signals. Sequence control is disabled, but the boost and ventilation functions are active.

The boost function gets deactivated:

- timer elapsed
- setpoint reached (VAV fix 15 minutes)
- change to another mode (AUTO or ECO)

### Operator level 2 – Configuration

### Application / Parameters

all CR24-..

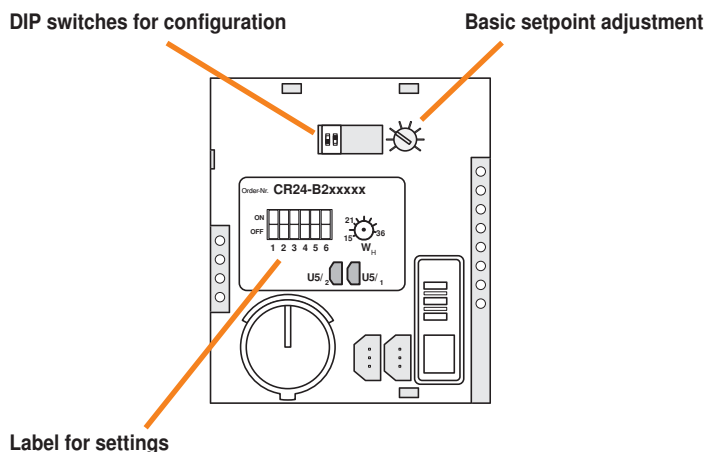

#### DIP switches for configuration

DIP switches 1 and 2 (CR24-B1, BR24-B2 and CR24-B2E) or 1 to 6 (CR24-B3)

#### Basic setpoint adjustment

Potentiometer 15...36°C (default 21°C)

#### Label for settings

Used to record the selected settings (DIP switches and basic setpoint).

### Operator level 3 – Service

### Test / Simulation

all CR24-..

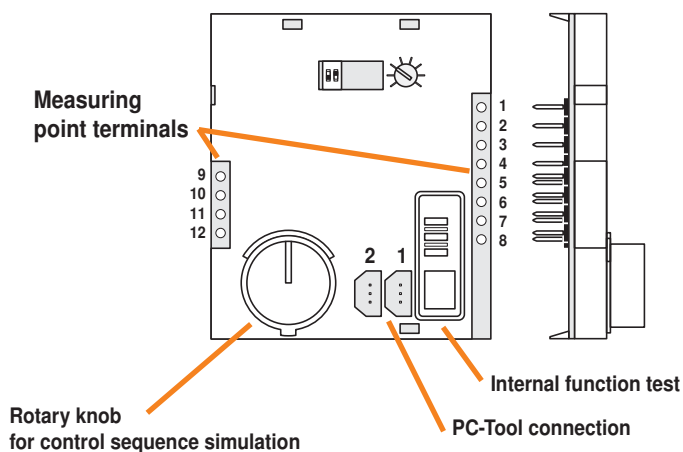

#### Measuring point terminals

Measuring points for all terminals (also during operation).

#### Internal function test

A comprehensive internal function test, including a nominal voltage test (AC 24 V), can be started for the controller with the mode switch. The three LEDs (status indication) indicate the voltage level and the states.

#### Control sequence simulation

The connected actuators, and thus also the heating and cooling control sequences, can be simulated independently of the room temperature with the rotary knob for adjusting the setpoint.

#### PC-Tool connection

Diagnostics sockets 1 and 2 are used for PP communication with the connected Belimo MFT actuators or VAV controllers. As a result, physical access to the field devices can be dispensed with.

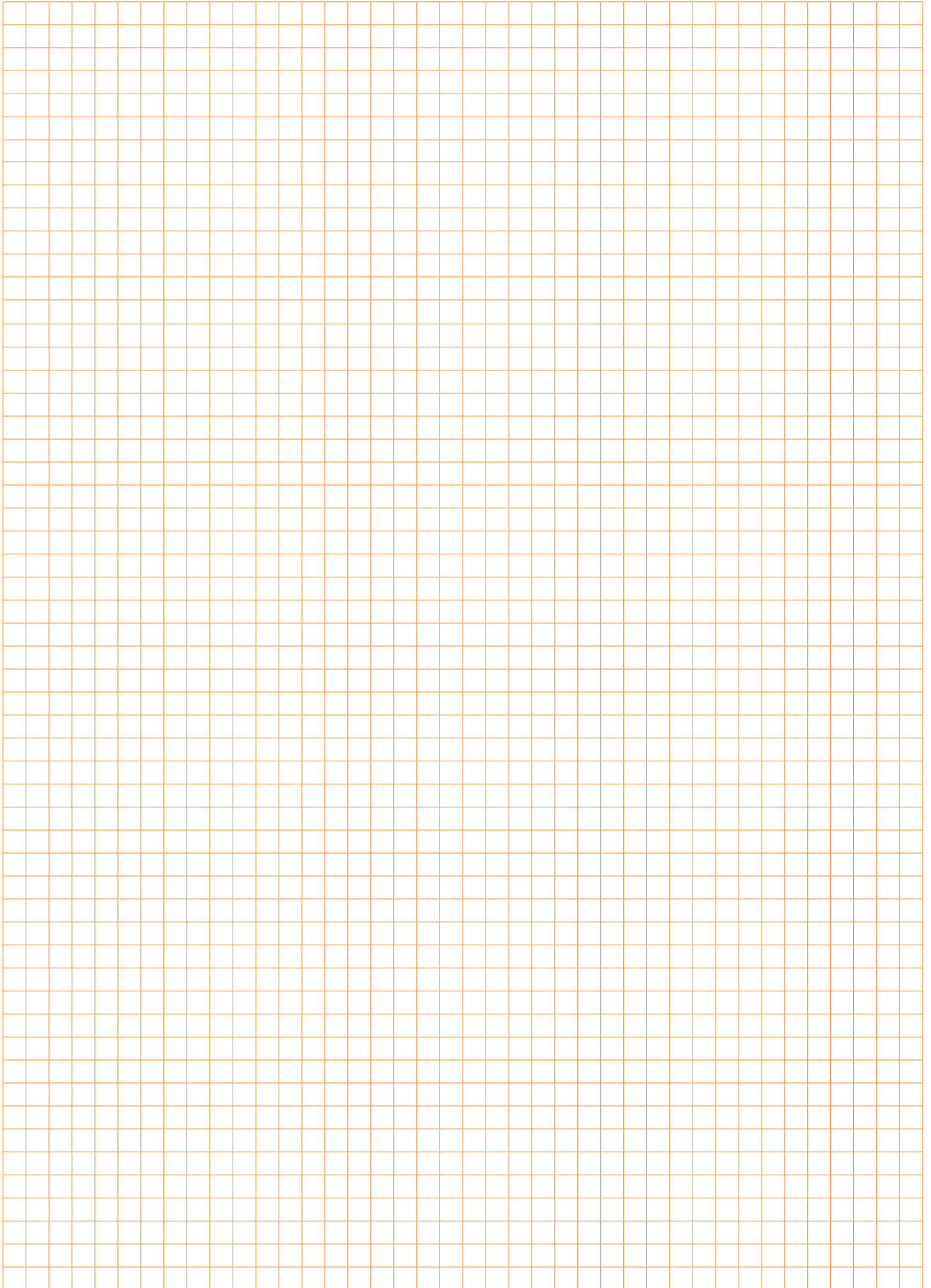



### Introduction

CR24-B.. only

The control functions define the behavior of the controller outputs and influence the current setpoint.

Both the level of comfort and the energy saving potential can be significantly enhanced by installing suitable sensors on the input side.

Please refer to the table on page 3 for an overview of the functions of the three basic CR24-B.. types. These functions are described in detail below.

### Setpoint calculation

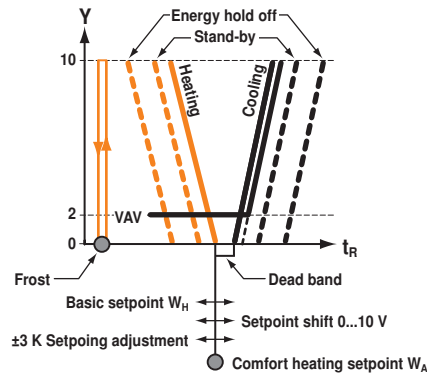

Operating status	Heating setpoint	Cooling setpoint
Comfort	Basic setpoint $W_H$ $\pm 3$ K Setpoint adjustment + Setpoint shift 0...10 V	Comfort heating setpoint $W_A$ + 1 K Dead band
Stand-by	Comfort heating setpoint $W_A$ - 2 K Stand-by offset heating	Comfort heating setpoint $W_A$ + 1 K Dead band + 3 K Stand-by offset cooling
Energy hold off	Fixed 15°C (building protection)	Fixed 40°C (building protection)
Frost	Fixed 10°C	Not relevant

#### Examples Comfort

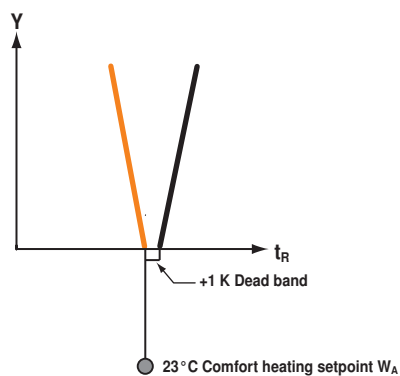

#### Stand-by

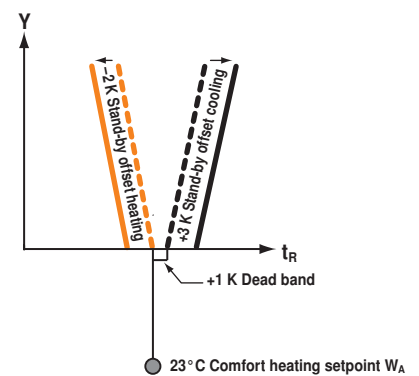

**Energy hold off**

**Digital input di1**

all CR24-..

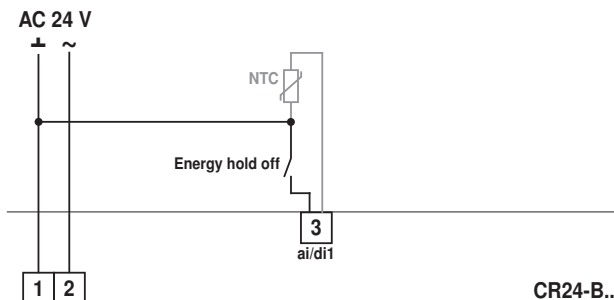

If a local detector (e.g. a window switch) acts on the digital input di1 and closes the corresponding contact, the room is adjusted to the building protection settings in energy saving mode, in other words the heating setpoint is significantly reduced (15°C) or the cooling setpoint significantly increased (40°C), though not sufficiently to cause damage to sensitive objects (plants, paintings etc.).

**Typical applications**

- A window switch at di1 stops all energy consumption from the moment the window is opened until the lower or upper building protection limit is reached.
- Higher-level override command, e.g. building management system.

**Notes**

- The minimum VAV output is set to 0 V instead of 2 V while energy hold off is active (forced closing in 2...10 V)
- The mode switch (operator level 1) is deactivated while energy hold off is active (input di1 takes priority).
- If an external temperature sensor is used, the frost limit is monitored by the internal sensor while energy hold off is active.
- Due to the automatic sensor detection the change into energy hold off takes about 40 seconds.

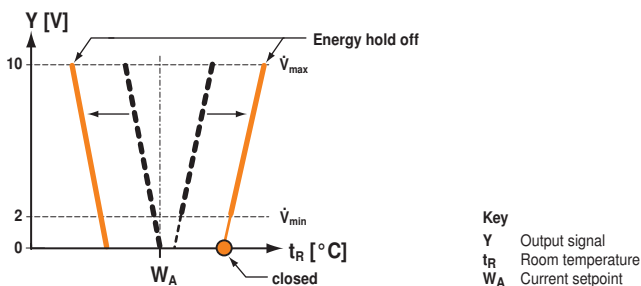

**Stand-by**

**Digital input di2**

all CR24-..

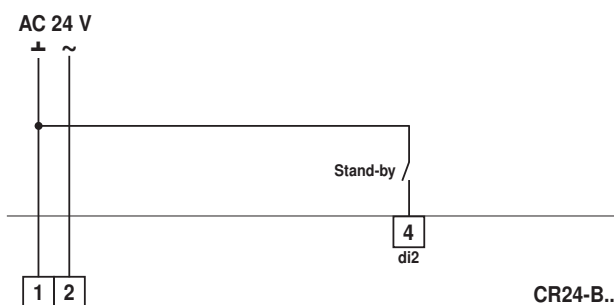

If a local detector (e.g. a motion detector) acts on the digital input di2 and closes the corresponding contact, the room is adjusted to the stand-by settings, in other words the heating setpoint is reduced by 2 K or the cooling setpoint is increased by 3 K.

**Typical applications**

- A motion detector, a light switch or another detector at di2 reduces the energy consumption of unoccupied rooms.
- Higher-level override command, e.g. building management system.

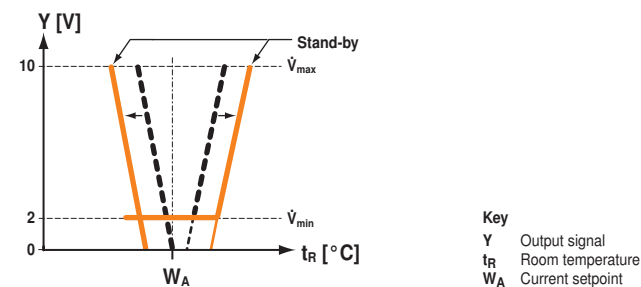

**VAV function: air volume in heating mode (Reheater)**

CR24-B2 und CR24-B3 only

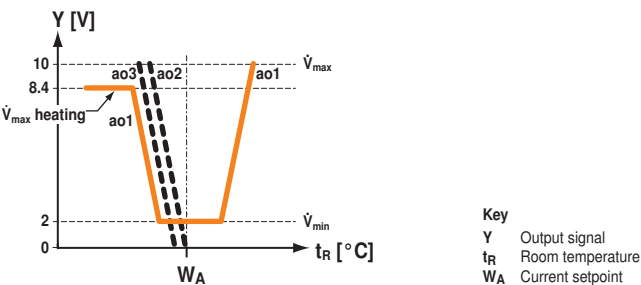

If the selected application requires an increased air volume for heating, e.g. for:

- Providing or assisting heating with air.
- Improving the air quality during heating.

**CR24-B2 configuration**

The VAV function is configured using DIP switch 2.



**CR24-B3 configuration**

The VAV function is configured using DIP switch 2.



**Electric air heater**

**CR24-B2E only**

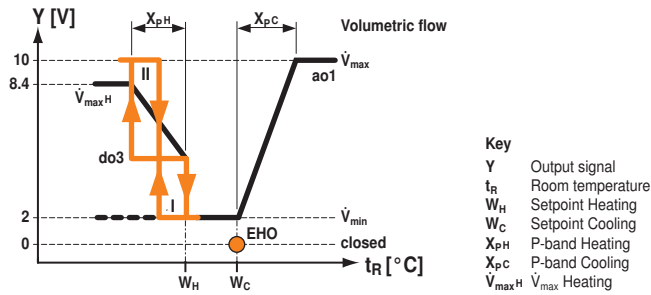

If the selected application requires an increased air volume for heating, e.g. for:

- Provision without assisting heating with air
- Improving the air quality during heating

**CR24-B2E configuration**

This function is activated using DIP switch 2.



**External temperature sensor**

**Analog input ai1**

**CR24-B1, CR24-B2, CR24-B3**

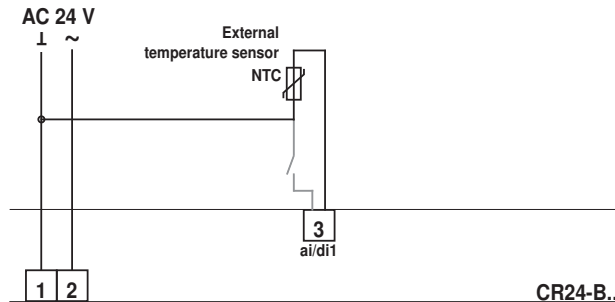

An external NTC temperature sensor can be connected to the analog input ai1.

**Typical application**

A temperature sensor measures the average room temperature in the exhaust air duct.

**Notes**

- The internal sensor automatically detects the presence of an external sensor.
- It is possible to install an energy hold off switch simultaneously at di1, in which case the system changes over to the internal sensor (see also "Energy hold off"). This permits the actual room temperature to be monitored in order to protect the building.

**Supply air temperature limitation**

**Analog input ai1**

**CR24-B2E only**

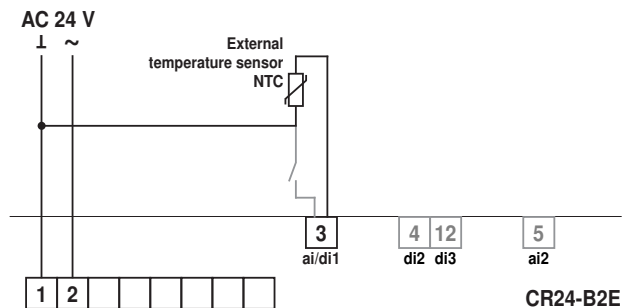

An external NTC temperature sensor can be connected to the analog input ai1. Sensor type: NTC 5k (5 kΩ)

Function: The temperature of the supply air is limited by shedding individual load increments if the maximum temperature is exceeded. This results in an almost modulating control characteristic.

Benefits: Increased comfort and economical energy consumption

**Notes**

- The controller automatically detects the presence of a supply air limitation sensor.
- Combined application with EHO switch:  
EHO active = supply air temperature limitation not active

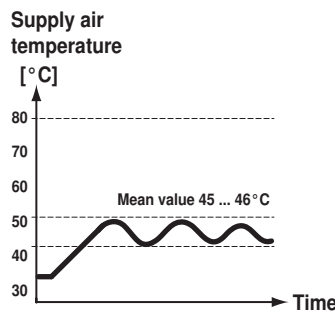
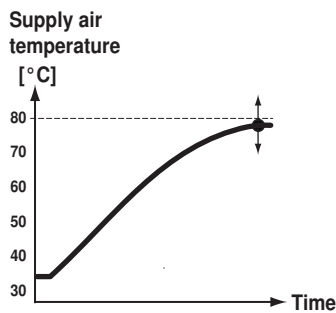

**External setpoint shift**

**Analog input ai2**

all CR24-..

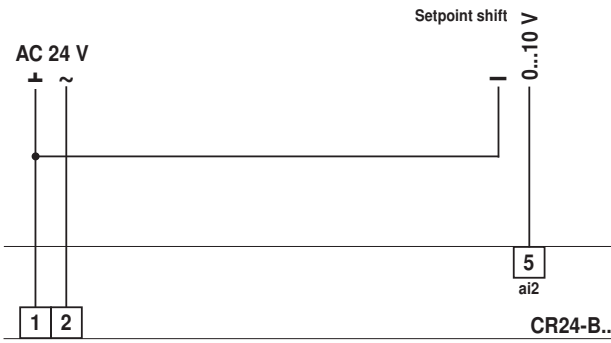

An external DC 0...10 V signal at the analog input ai2 can be used to shift the basic setpoint 0...10 K (corresponds to 0...10 V).

**Typical application**

- Summer/winter compensation

**Notes**

A negative shift can be achieved by adjusting the basic setpoint to the required final setpoint, e.g. from 21 °C (default value) to 16 °C. In this case:

- 0... 5 V corresponds to 16...21 °C and
- 5...10 V corresponds to 21...26 °C (see diagram opposite).

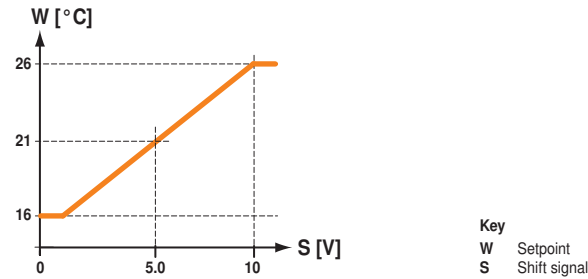

**Air flush**

**Digital input di3**

CR24-B2 only

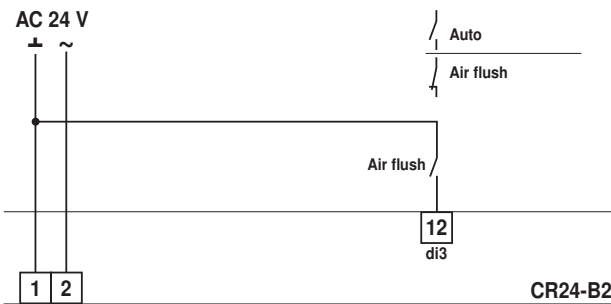

The CR24-B2 controller allows override control at the digital input di3, to enable the room to be flushed with the maximum volume flow ( $\dot{V}_{max}$ ).

**Typical applications**

- Purging conference rooms, hotel rooms etc. (e.g. time switch-controlled)
- Assisting smoke extraction
- Controlling air quality (2-point signal)

**Notes**

- The VAV output ao1 is set to a fixed value of  $\dot{V}_{max}$  (10 V).
- The heating output ao3 remains in the normal control mode and continues to be controlled by means of the heating sequence.

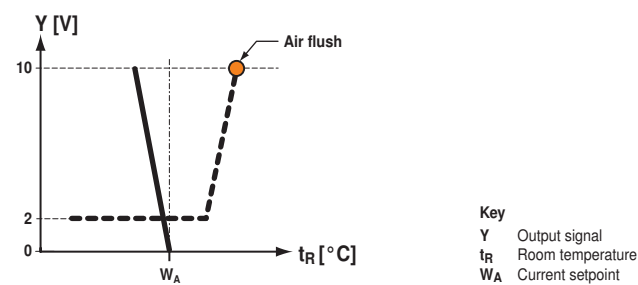

**Change-over ao1**

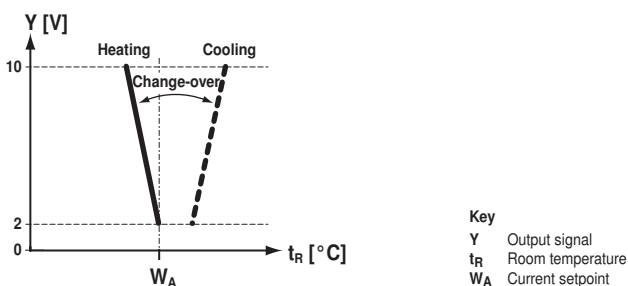
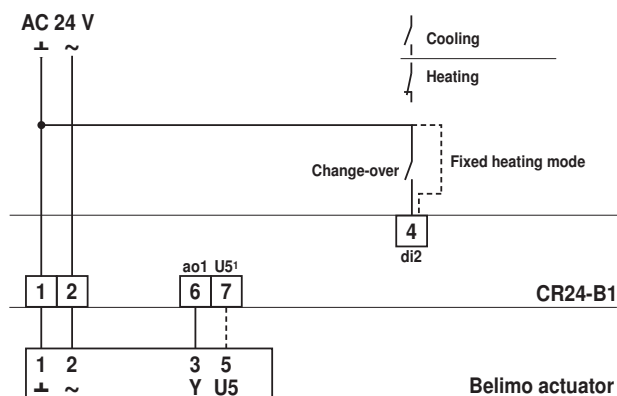

**Digital input di2**

CR24-B1 only

In change-over applications, the digital input di2 controls the VAV system output ao1 of the CR24-B1 controller.

**Typical applications**

Change-over heating or heating/cooling.

**Note**

The CR24-B3 controller is suitable for applications that require both a stand-by function and a change-over function.

**Configuration**

The change-over function is configured using DIP switch 2



**Change-over ao2**

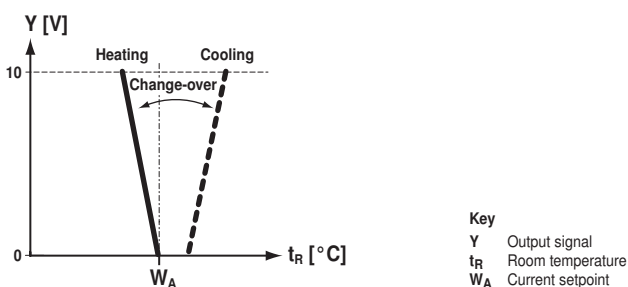
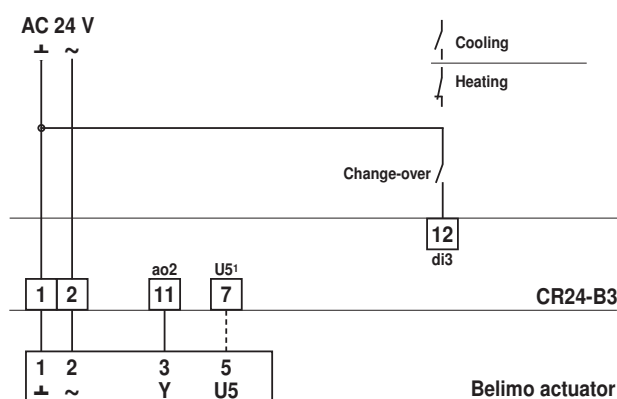

**Digital input di3**

CR24-B3 only

In change-over applications, the digital input di3 controls the common heating/cooling output ao2 of the CR24-B3 controller.

**Typical applications**

Change-over heating or heating/cooling.

**Note**

- For chilled ceiling applications, refer to page 23.
- The CR24-B1 controller is suitable for applications that only require a change-over function.

**Configuration**

The change-over function is configured using DIP switches 3 and 4.



**Boost –  $\dot{V}_{max}$**

**Digital input di3**

**CR24-B3 only**

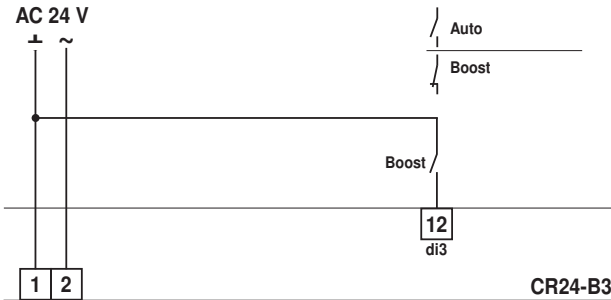

The CR24-B3 controller allows override control at the digital input di3, to enable the room to be ventilated with the maximum air flow ( $\dot{V}_{max}$ ). This function acts on all three analog outputs (see "Notes"). Room temperature control is deactivated in this mode (exception: frost protection function).

**Typical applications**

- Purging conference rooms, hotel rooms etc.
- Assisting smoke extraction
- Free- or night cooling

**Notes**

The boost function acts on the outputs as follows:

- ao1 (VAV) 100% > 10 V ( $\dot{V}_{max}$ )
- ao2 (heating/cooling) 0% > 0 V
- ao3 (heating) 0% > closed (3-point)

The boost function is deactivated by the following events:

- Boost signal (di3) not active
- Frost limit temperature (10°C) undershot

**Configuration**

This boost function is configured using DIP switches 4 (boost on) and 5 (boost  $\dot{V}_{max}$ ).

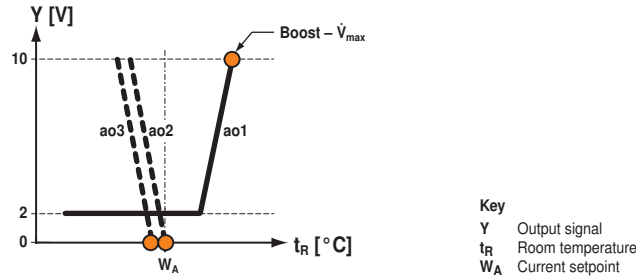

**Boost – Temperature-controlled**

**Digital input di3**

**CR24-B3, CR24-B2E**

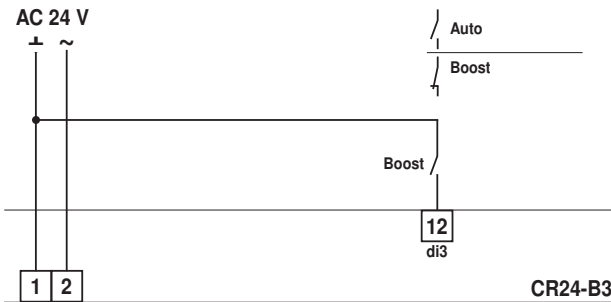

The CR24-B3 resp. CR24-B2E controller allows override control at the digital input di3, to enable the room to be heated or cooled with the maximum capacity. This function acts on all three analog outputs (see "Notes").

**Typical applications**

- Rapid heating, rapid cooling
- Cooling, morning boost etc.

**Notes**

The boost function acts temperature-sensitive on the outputs as follows

- CR24-B3:
- ao1 (VAV) 100% > 10 V ( $\dot{V}_{max}$ )
  - ao2 (heating/cooling) 100% > 10 V
  - ao3 (heating) 100% > open (3-point)

CR24-B2E:

- ao1 (VAV) 100% > 10 V ( $\dot{V}_{max}$ )
- do3 / 1 ON
- do3 / 2 ON

To support reheater applications the VAV system output (ao1) gets activated at the heating condition too.

The boost function is deactivated by the following events:

- Boost signal (di3) not active
- Comfort setpoint (W) reached

The air is always conditioned to the comfort setpoint W, even if stand-by (d1) is active, in order to facilitate room preconditioning.

**Configuration (CR24-B3 only)**

This boost function is configured using DIP switches 4 (boost on) and 5 (boost temperature-controlled).

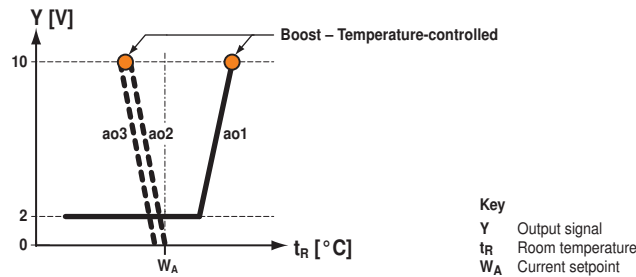

**Chilled ceiling with dew point limiting**

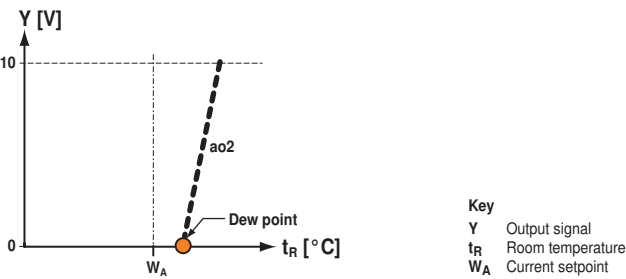
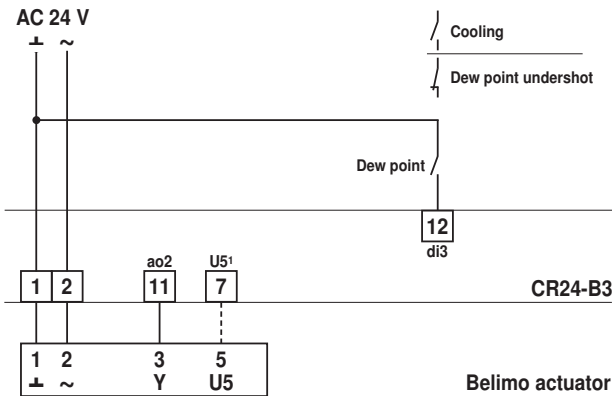

**Digital input di3**

CR24-B3 only

If the temperature at the external dew point monitor (input di3) falls below the dew point, output ao2 is set to 0 V.

**Typical applications**

Chilled ceiling systems that require dew point limiting.

**Configuration**

This function is configured using DIP switches 3 and 4.



**Chilled ceiling with dew point limiting and change-over**

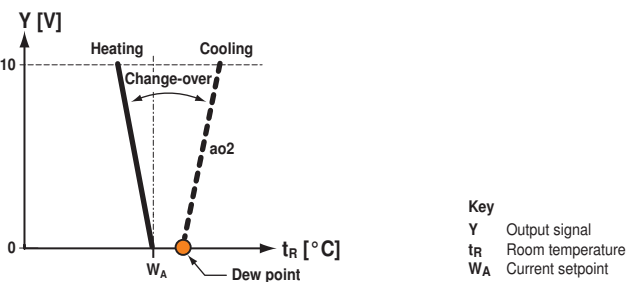
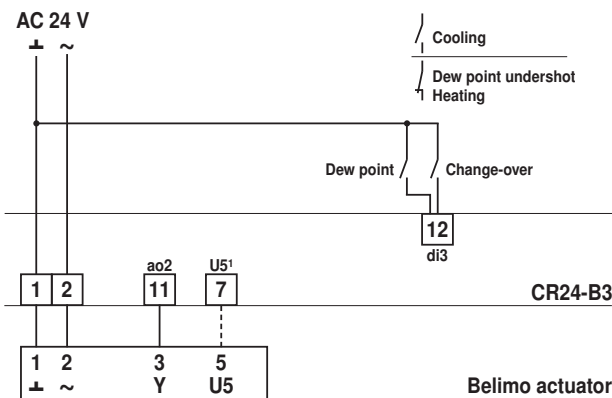

**Digital input di3**

CR24-B3 only

If the temperature at the external dew point monitor (input di3) falls below the dew point, output ao2 is set to 0 V. Dew point limiting can be combined with the change-over function.

**Typical applications**

Switchable heated/chilled ceiling systems that also require dew point limiting.

**Configuration**

This function is configured using DIP switches 3 and 4.



## Rolling start

CR24-B2E only

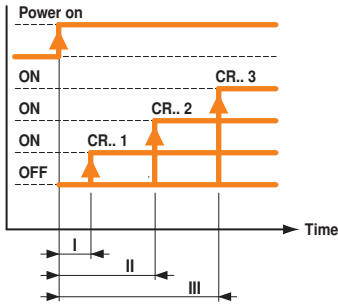

An ingenious startup function prevents overload situations when the power is switched on and stops fuses from being tripped if several air heaters are operated with the same voltage supply.

## Power-on behavior

- Power on
- Delay I Electric air heater of the first CR24-B2E enabled
- Delay II Electric air heater of the second CR24-B2E enabled
- Delay III Electric air heater of the third CR24-B2E enabled
- etc.

## Excess temperature protection

CR24-B2E only

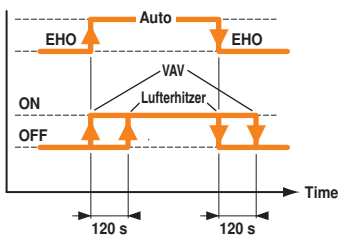

This function prevents the local safety interlock (STh) from responding unless absolutely necessary and relieves the load on devices and installations.

When the system is started up after a power on or EHO off, or when EHO active is switched off, the air heater output is switched on after a delay and the VAV output is switched off after a delay.

## Step control

CR24-B2E only

## Single steps

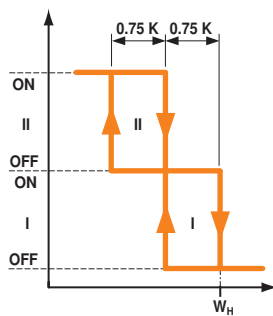

The B2E supports two AH control modes:

- Single steps: Simple electric air heaters or open/close radiator/zone valves
- Binary steps: 2-step electric air heaters in 3-step mode, e.g. 1/3 - 2/3 - 3/3

## CR24-B2E configuration

This function is configured using DIP switch 1.

- Einzelstufen: Simple electric air heaters or open/close radiator/zone valves



(Factory setting)

## Binary steps

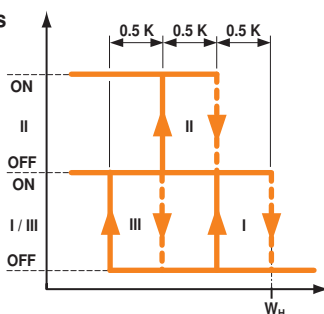

- Binärstufen: 2-step electric air heaters in 3-step mode, e.g. 1/3 - 2/3 - 3/3





### Dimensions [mm]

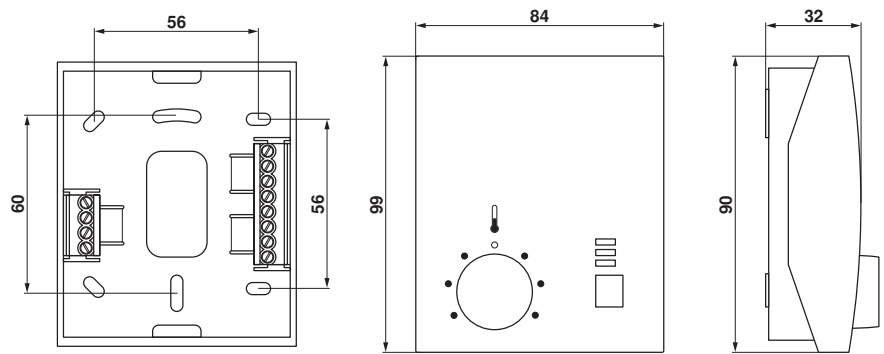

### Mechanical installation

1. Remove the housing cover.
2. Pull out slightly the wall of the housing to release the pcb.
3. Remove the printed circuit board.

### Rotary knob for setpoint adjustment

If the rotary knob has been removed proceed as follows:

- a. Insert the rotary knob approximately half way and turn it clockwise as far as the stop.
- b. Remove the knob and align it so that the cam is flush with the left stop.
- c. Insert the knob fully.

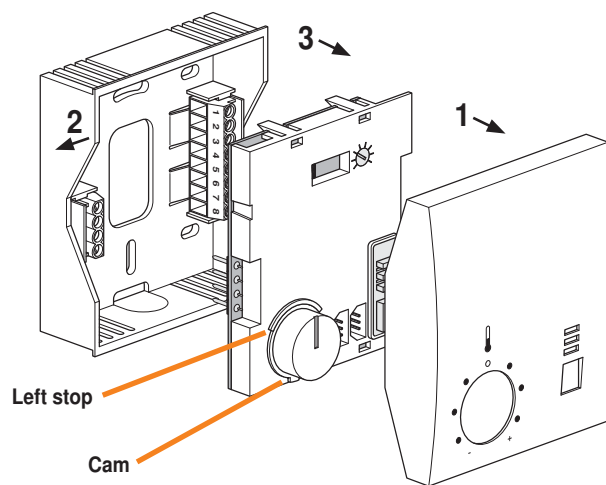

### Electrical installation

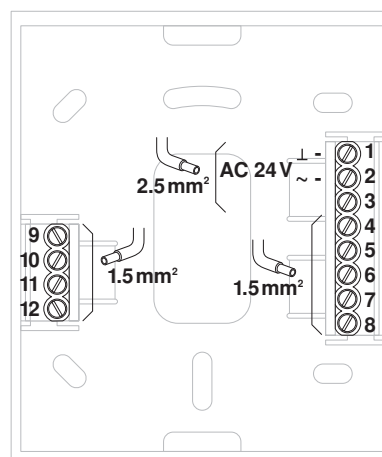
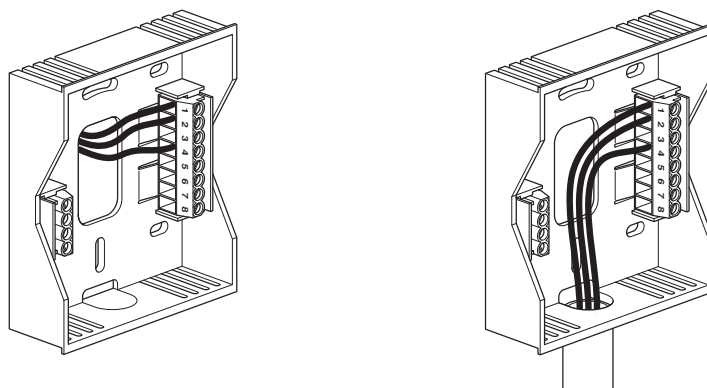

## Power supply design / wire sizing

In addition to the actual wire sizing, attention must also be paid to the surrounding area and the cable routing. Signal cables must not be laid in the vicinity of load cables, objects liable to cause EMC interference etc. Paired or layer stranded cables improve immunity to interference.

### 24 V supply Wire sizing and cabling

The wire sizing and installation of the AC 24 V supply, the fuse protection, and the cables are dependent on the total operated load and local regulations.

Account must be taken of the following performance data, including starting currents:

- Wire sizing values for room temperature controllers: 3 VA per CR24-...
- Wire sizing values for control devices, VAV controllers, damper actuators, valves etc. can be found in the latest data sheets and product information ([www.belimo.com](http://www.belimo.com))
- Other devices to be operated with the AC 24 V supply
- Reserve capacity for subsequent expansion (if planned)

### Digital input connections di1 / di2 / di3

The digital inputs of the CR24 controllers are connections with a low electrical load that can be controlled by a common switching contact if necessary.

Example: Common thermostat for changeover function.

The maximum cable length depends on the number of CR24 controllers and the cross section of the cable used or the maximum resistance of the cable and switching contact as well as the quality of the environment.

No. of CR24-...	Cable cross section	Cable length
10	0.75 mm <sup>2</sup>	max. 250 m
20	0.75 mm <sup>2</sup>	max. 200 m
20	1.00 mm <sup>2</sup>	max. 250 m
25	0.75 mm <sup>2</sup>	max. 170 m
25	1.00 mm <sup>2</sup>	max. 220 m
25	1.50 mm <sup>2</sup>	max. 250 m
30	0.75 mm <sup>2</sup>	max. 140 m
30	1.00 mm <sup>2</sup>	max. 190 m
30	1.50 mm <sup>2</sup>	max. 250 m
40	0.75 mm <sup>2</sup>	max. 100 m
40	1.0 mm <sup>2</sup>	max. 140 m
40	1.50 mm <sup>2</sup>	max. 210 m
50	0.75 mm <sup>2</sup>	max. 80 m
50	1.00 mm <sup>2</sup>	max. 110 m
50	1.50 mm <sup>2</sup>	max. 170 m

If the number of CR24-.. controllers exceeds that indicated in the table, the next higher number of CR24-.. controllers should be taken instead.

Example of a system with 13 CR24-B1 controllers and a common C/O contact:

Use the table data for 20 CR24-.. controllers to design the cable:

20 x CR24-.. → 0.75 mm<sup>2</sup> → 200 m.

#### Note

This table does not apply to the design of the AC 24 V power supply cable.  
The supply cable is determined by the total power of all loads (see above).

### Analog input connection ai1

The analog input ai1 is used to connect an external NTC 5 kΩ temperature sensor. The sensor value is 5969 Ω at 21 °C. A change of 50 Ω corresponds to approximately 0.2 K in this range. The sensor cable constitutes a series resistance that must be added to the actual sensor value. Assuming a cable length of 15 m (2 x 15 = 30 m), the resistance of one 0.75 mm<sup>2</sup> Cu cable is approximately 0.7 Ω, in other words negligible.

To prevent interference, however, the sensor cable should be a maximum of 20 m long.

### Analog input connection ai2

The 0...10 V input (with the 10 kΩ pulldown resistor) can be used to connect an external 0...10 V signal for a setpoint shift.

The current is calculated according to Ohm's Law:  $I = U / R$ : 10 V / 10 kΩ = 1 mA.

Calculation: Maximum permissible voltage drop across the cable (V) divided by the current (1 mA) = cable impedance in Ω.

**Commissioning / Power on behaviour**

- Commissioning**
1. Assemble the baseplate of the housing and connect the cables (see page 15).
  2. Configure the DIP switches on the printed circuit board according to the required application.
  3. Assemble the printed circuit board on the baseplate of the housing and then mount the housing cover (see page 15).
  4. Switch on the nominal voltage (AC 24 V).
  5. Optional: start the test and simulation mode (see below).

When the voltage is applied, the system starts operating normally in AUTO mode (unless the test and simulation mode is selected). The active operating status is determined primarily by the configuration of the DIP switches and the status of the inputs

- Power on behaviour**
- After power on of the voltage supply the output gets initialized as follows:
- ao1 = 0 V
  - ao2 = 0 V
  - ao3 = closed (200 s)

Subsequently the controller switches automatically to the control mode.

**Test and simulation mode**

All controllers are supplied with two auxiliary programs for commissioning and servicing:

- Internal function test
- Control sequence simulation

**Activating test and simulation mode**

The test and simulation mode of CR24-B.. controllers can be activated easily with the mode switch on the operator panel. With CR24-A.. controllers, the housing cover must be removed first.

**To activate test mode**

1. Set the mode switch to MAX
  - The red LED (MAX status indication) lights up
2. Keep the mode switch pressed for ten seconds
  - The internal function test is activated (see below)

**To activate simulation mode**

3. Press the mode switch again briefly (for approximately one second)
  - The green LED (AUTO status indication) flashes
  - Control sequence simulation is activated (see below)

**Deactivating test and simulation mode**

The test and simulation mode can be deactivated either by pressing the mode switch again for ten seconds or by interrupting the power supply. It is also deactivated automatically 15 minutes after the last user action (auto-reset).

**Internal function test**

The internal function test tests the nominal voltage that is connected to the controller (AC 24 V), in other words the complete electrical wiring system from the control cabinet to the controller. The three LEDs (status indication) indicate the voltage level (see below) and states during the test.

**Nominal voltage (AC 24 V)**

LED (status indication)	Scenario A	Scenario B	Scenario C
MAX red	flash	flash	permanently on
ECO orange	flash	flash	permanently on
AUTO green	permanently off	flash	permanently on
	<20 V	20...22 V	>22 V

**Note**

Case B and C do not need further attention. In case A (<20 V) attention must be paid to the following points:

- Quality of the wiring and connections
- Cable length/diameter and the transformer sizing.

## Control sequence simulation

## (CR24-B1, CR24-B2, CR24-B3)

## CR24-B1, CR24-B2, CR24-B3

The connected actuators, and thus also the heating and cooling control sequences, can be simulated independently of the room temperature in simulation mode. This permits the air volume ( $\dot{V}_{\min}$  and  $\dot{V}_{\max}$ ) to be tested in air systems or the maximum heating and cooling capacity in water systems.

## Notes

- The external control signals (di1, di2 and di3) are suppressed while the simulation is active.
- The potentiometer changes during simulation mode should be done slowly to avoid overshooting of the output values due to the system depending adjuster damping.
- A-types (controllers without operation panel): please do reset the potentiometer to the 0-position after simulation to avoid setpoint deviations.
- Simulation mode is automatically deactivated 15 minutes after the last user action (auto-reset).

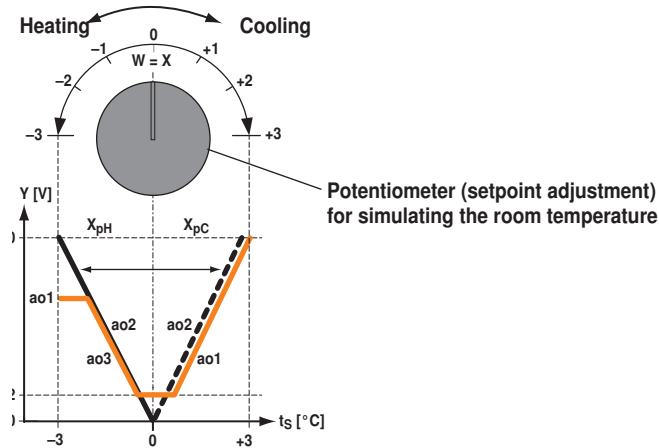

## CR24-B2E

The simulation mode for the CR24-B2E is basically as described above.

Unlike water operated air heaters, electric air heaters are not allowed to be operated without a flow. Simulations can be carried out on the CR24-.. at any time, even if the ventilation system is not operating.

The two triac outputs are activated for a maximum of 15 seconds in simulation mode to prevent overheating due to operation without ventilation. To activate these outputs again, the potentiometer must be reset via the "0" position to the heating range.

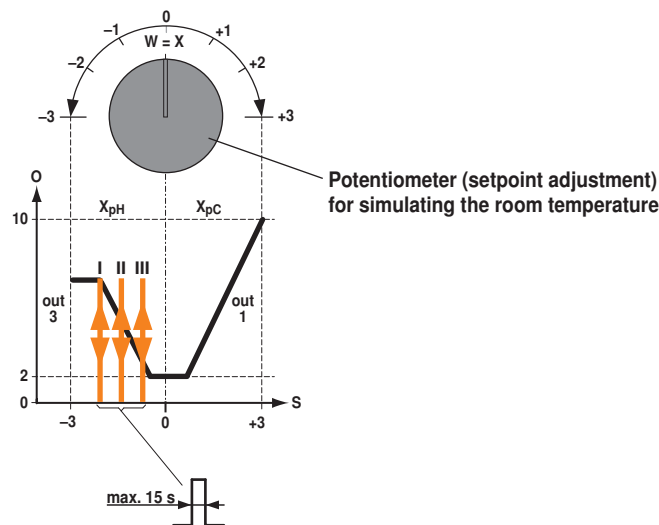

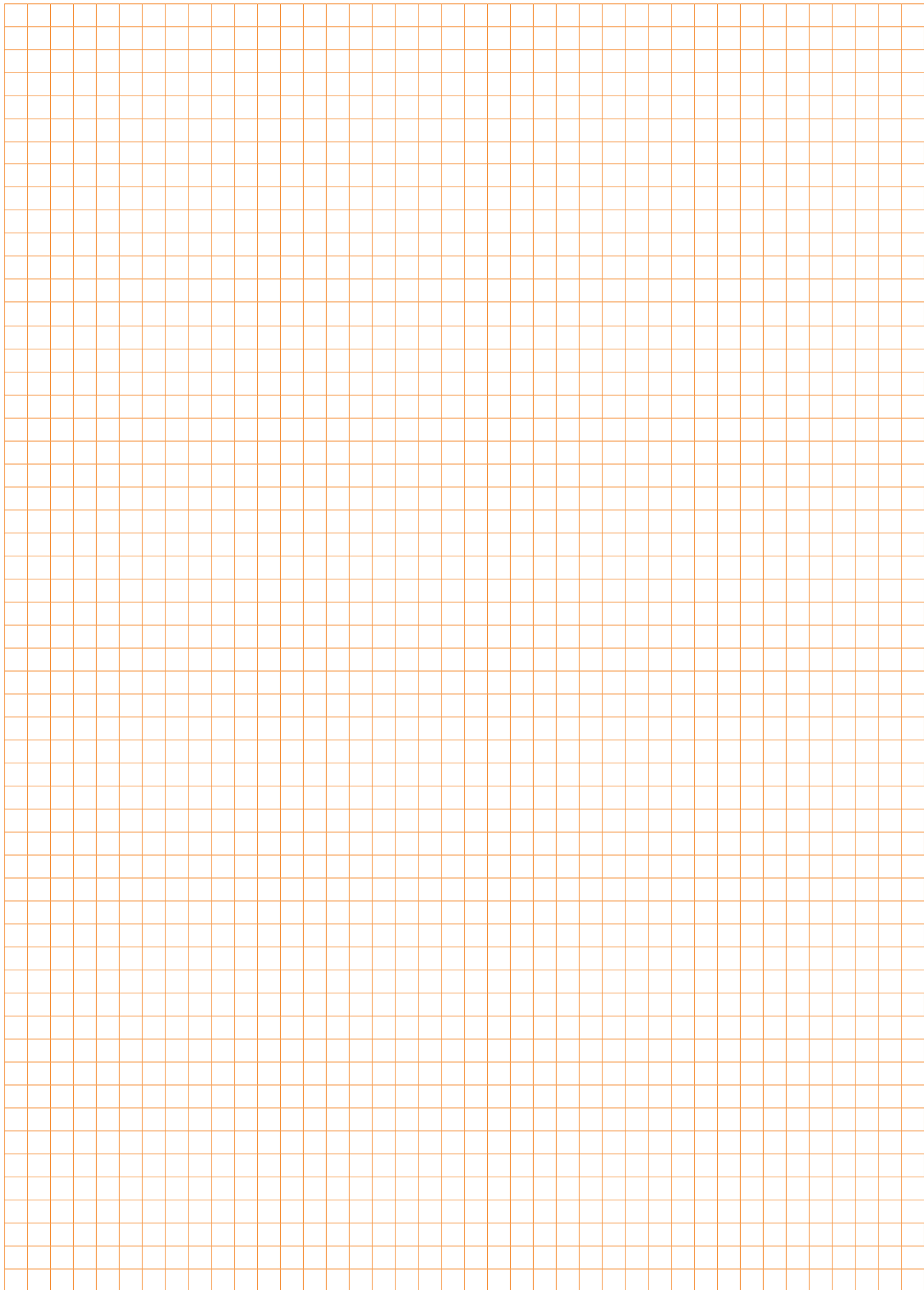

**ASIA PACIFIC HEADQUARTERS**

Belimo Actuators (Shanghai) Trading Ltd.  
479 Chun Dong Road, Building C-2  
Xin Zhuang Industry Park  
Shanghai 201108, P.R. China  
Tel: +86 21 5483 2929  
Fax: +86 21 5483 2930  
E-mail: info.asiapacific@belimo.ch

**Belimo AUSTRALIA**

**Melbourne Office:**  
Belimo Actuators Pty. Ltd.  
12 Enterprise Court  
Mulgrave Business Park  
Mulgrave, VIC 3170, Australia  
Tel: +61 (0)3 9545 0844  
Fax: +61 (0)3 9545 0855  
E-mail: info.australia@belimo.ch

**Sydney Office:**

Belimo Actuators Pty. Ltd.  
Suite 2.20, 32 Delhi Road  
North Ryde, NSW 2113  
Australia  
Tel: +61 (0)2 9805 1777  
Fax: +61 (0)2 9805 1722  
E-mail: info.australia@belimo.ch

**Belimo CHINA**

**Shanghai Office:**  
Belimo Actuators (Shanghai) Trading Ltd.  
479 Chun Dong Road, Building C-2  
Xin Zhuang Industry Park  
Shanghai 201108, P.R. China  
Tel: +86 21 5483 2929  
Fax: +86 21 5483 2930  
E-mail: info.shanghai@belimo.ch

**Beijing Office:**

Belimo Actuators Ltd.  
Room 605, Hai Chang Edifice  
44 Liang Ma Qiao Road  
Beijing 100016, P.R. China  
Tel: +86 10 6462 1382  
Fax: +86 10 6462 1383  
E-mail: info.beijing@belimo.ch

**Chongqing Office:**

Belimo Actuators Ltd.  
Room 4, 9th floor, Unit 7, Luoma Jiari Garden  
No. 36, QingLong Road, Nan'an District  
Chongqing 400060, P.R. China  
Tel: +86 23 6275 3155  
Fax: +86 23 6280 3380 \*519  
E-mail: info.chongqing@belimo.ch

**Guangzhou Office:**

Belimo Actuators Ltd.  
Room 1202, Skyline Plaza  
644 Tong Fu East Road, Haizhu Area  
Guangzhou 510240, P.R. China  
Tel: +86 20 3435 1860  
Fax: +86 20 3435 1870  
E-mail: info.guangzhou@belimo.ch

**Belimo HONG KONG**

**Hong Kong Office:**  
Belimo Actuators Ltd.  
Room 207, 2/F, New Commerce Center  
19 On Sum Street, Shatin, N.T., Hong Kong  
Tel: +852 2687 1716  
Fax: +852 2687 1795  
E-mail: info.hongkong@belimo.ch

**Japan Office:**

Belimo Actuators Ltd.  
7th Floor, Honjo-Azumabashi DJ Building  
4-19-3, Honjo, Sumida-ku  
Tokyo 130-0004, Japan  
Tel: +81 3 6823 6961  
Fax: +81 3 3626 3911  
E-mail: info.japan@belimo.ch

**Malaysia Office:**

Belimo Actuators Ltd.  
12-1, Jalan PJS 10/2, Subang Indah  
46000 Petaling Jaya Selangor, Malaysia  
Tel: +603 5631 2188  
Fax: +603 5638 2189  
E-mail: info.malaysia@belimo.ch

**Singapore Office:**

Belimo Actuators Ltd.  
1 Tannery Road #08-04, One Tannery  
Singapore 347719  
Tel: +65 6842 1626  
Fax: +65 6842 1630  
E-mail: info.singapore@belimo.ch

**Taiwan Office:**

Belimo Actuators Ltd.  
7F-2, No. 343, Jhonghe Road, Yonghe City  
Taipei County 234, Taiwan  
Tel: +886 2 2922 8805  
Fax: +886 2 2922 8806  
E-mail: info.taiwan@belimo.ch

**Thailand Office:**

Belimo Actuators Ltd.  
90/2 Pensiri Place  
Soi Phaholyothin 32, Phaholyothin Road  
Chandrakasem, Jatujak  
Bangkok 10900, Thailand  
Tel: +662 9415582-3  
Fax: +662 9415584  
E-mail: info.thailand@belimo.ch

**Belimo INDIA**

**Mumbai Office:**  
Belimo Actuators India Pvt. Ltd.  
23/ ABCD, Govt. Industrial Estate,  
Charkop, Kandivali West,  
Mumbai 400067, India  
Tel: +91 22 4025 4800  
Fax: +91 22 4025 4899  
E-mail: info.india@belimo.ch

**Bangalore Office:**

Belimo Actuators India Pvt. Ltd.  
Sreerama Complex,  
No. 13, 2nd Floor, 5th Cross Road,  
6th Block, Koramangala,  
Bangalore 560097, India  
Tel: +91 80 4090 6311  
Fax: +91 80 4090 6288  
E-mail: info.india@belimo.ch

**New Delhi Office:**

Belimo Actuators India Pvt. Ltd.  
Flat No. 516, DLF Tower – B,  
Jasola Distt. Centre, Jasola,  
New Delhi 110025, India  
Phone: +91 11 4107 8501 to 4107 8507  
Fax: +91 11 4107 8508  
E-mail: info.india@belimo.ch

**Chennai Office:**

Belimo Actuators India Pvt. Ltd.  
#25, Bagavadam Street, T-Nagar  
Chennai 600017, India  
Tel: +91 44 4299 9450  
Fax: +91 44 4299 9451  
E-mail: info.india@belimo.ch

# Innovation, Quality and Consultancy: A partnership for motorising HVAC Actuators



5 year warranty



On site around the globe



A complete range of products from one source



Tested quality



Short delivery times



Comprehensive support

[www.belimo.com](http://www.belimo.com)

#### Belimo regional head offices

EU BELIMO Automation AG  
Brunnenbachstrasse 1  
8340 Hinwil, Switzerland  
Tel: +41 43 843 61 11  
Fax: +41 43 843 62 68  
E-mail: [info@belimo.ch](mailto:info@belimo.ch)

AP BELIMO Actuators (Shanghai) Trading Ltd.  
479 Chun Dong Road, Building C-2  
Xin Zhuang Industry Park  
Shanghai 201108, P.R. China  
Tel: +86 21 5483 2929  
Fax: +86 21 5483 2930  
E-mail: [info.asiapacific@belimo.ch](mailto:info.asiapacific@belimo.ch)

US BELIMO Aircontrol (USA), Inc.  
43 Old Ridgebury Road  
Danbury, CT 06813-2928, USA  
Tel: +800 543-9038 / 203 791-9915  
Fax: +800 228-8283 / 203 791-9919

Or contact your nearest Sales Representative

**BELIMO**<sup>®</sup>